



Indoor commercial/residential LED flush mount fixtures

So simple, so innovative – perfect for so many projects. Slim, efficient and easy to install. This is what Lijiacheng can provide to you. Lijiacheng LED Surface Mount fixtures come in the sizes, shapes, finishes and specifications that make solving most any lighting problem easy. No room for a recessed can fixture? No problem. If there's only a 3" or 4" junction box or a pancake box to work with, mounting is simple, ultra-slim design – makes it the answer for so many hard to light spaces. It is perfect for so many venues both residential and commercial. Kitchens, bathrooms, hallways, meeting rooms, offices and retail venues all benefit from this simple, efficient LED fixture.

5"/ 7" Slim Surface Mount Downlight - Round

Features

- One piece plastic flange. Injection molded white, applied Satin Nicke or black
- High transmittance lens allowing for smooth, comfortable light pattern
- Installs into standard j-box applications for 5" & 7" models
- Mounts directly to a standard junction box
- Available in 2700K, 3000K, 3500K, 4000K or 5000K
- Utilizes high performing LED with 90+CRI
- Expected lifetime 50,000 hours and backed by a 5 years warranty
- Wet Location listed with standard non-metallic housing

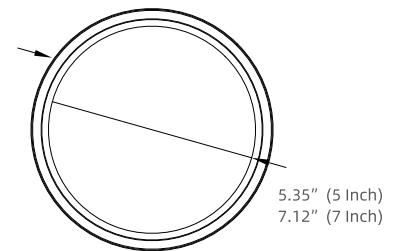

Applications

- Kitchens
- Bathrooms
- Hallways
- Meeting rooms
- Hospitality
- Health care
- Offices
- Retail

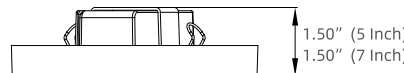

Finish Options



Jbox Applications



Dimension

Type	Length (Inch)	Width (Inch)	Height (Inch)	Weight (LB)
5inch	5.35	5.35	1.5	0.51
7inch	7.12	7.12	1.5	0.71

Specifications

Series	CRI	Power	CCT	Lumens	Efficacy	Dimmable
HT-G11CEDL-RD5-C09-XXS-ZZV	80/90	9W	3000/3500/4000/5000K	650/550LM	72/61LM/W	Y
HT-G11CEDL-RD5-C10-XXS-ZZV	80/90	10W	3000/3500/4000/5000K	850/750LM	85/75LM/W	Y
HT-G11CEDL-RD5-C12-XXS-ZZV	80/90	12W	3000/3500/4000/5000K	1000/850LM	83/71LM/W	Y
HT-G11CEDL-RD7-C12-XXS-ZZV	80/90	12W	3000/3500/4000/5000K	1100/1000LM	92/83LM/W	Y
HT-G11CEDL-RD7-C14-XXS-ZZV	80/90	14W	3000/3500/4000/5000K	1200/1100LM	86/79LM/W	Y

5"/ 7" Slim Surface Mount Downlight - Square

Features

- One piece plastic flange. Injection molded white, applied Satin Nicke or black
- High transmittance lens allowing for smooth, comfortable light pattern
- Installs into standard j-box applications for 5''&7'' models
- Mounts directly to a standard junction box
- Available in 2700K, 3000K, 3500K, 4000K or 5000K
- Utilizes high performing LED with 90+CRI
- Expected lifetime 50,000 hours and backed by a 5 years warranty
- Wet Location listed with standard non-metallic housing



Applications

- Kitchens
- Bathrooms
- Hallways
- Meeting rooms
- Hospitality
- Health care
- Offices
- Retail

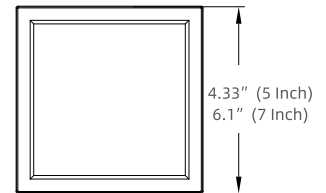
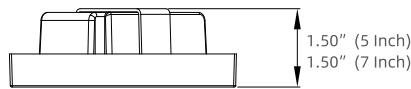

Finish Options

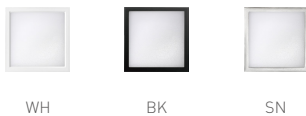

Jbox Applications



Dimension

Type	Length (Inch)	Width (Inch)	Height (Inch)	Weight (LB)
5inch	4.33	4.33	1.5	0.51
7inch	6.1	6.1	1.5	0.71

Specifications

Series	CRI	Power	CCT	Lumens	Efficacy	Dimmable
HT-G1YCEDL-SD5-C09-XXS-ZZV	80/90	9W	3000/3500/4000/5000K	650/550LM	72/61LM/W	Y
HT-G1YCEDL-SD5-C10-XXS-ZZV	80/90	10W	3000/3500/4000/5000K	850/750LM	85/75LM/W	Y
HT-G1YCEDL-SD5-C12-XXS-ZZV	80/90	12W	3000/3500/4000/5000K	1000/850LM	83/71LM/W	Y
HT-G1YCEDL-SD7-C12-XXS-ZZV	80/90	12W	3000/3500/4000/5000K	1100/1000LM	92/83LM/W	Y
HT-G1YCEDL-SD7-C14-XXS-ZZV	80/90	14W	3000/3500/4000/5000K	1200/1100LM	86/79LM/W	Y

LED Surface Mount Downlight With Battery Back-Up

Features

- One piece plastic flange. Injection molded white, applied Satin Nicke or black
- High transmittance lens allowing for smooth, comfortable light pattern
- Installs into standard j-box applications for 7" models
- Integral class 2 driver
- 120V 60Hz
- Available in 2700K, 3000K, 3500K, 4000K or 5000K
- Utilizes high performing LED with 90+CRI
- Expected lifetime 50,000 hours and backed by a 5 years warranty
- 400LM of emergency lumens with more than 90min

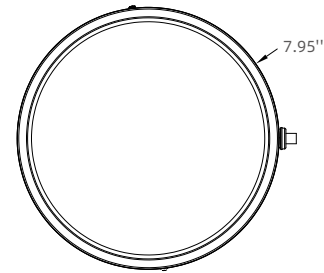
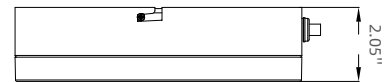

The factory-installed, integral battery back-up option powers fixtures during outages.

This option eliminates the need and maintenance involved in installing a separate emergency fixture, or having to wall mount a fixture susceptible to physical damage. A factory-installed, empty back box can be added to the additional fixtures within the space to match the battery box depth and provide a more consistent appearance.

Dimension

Type	Length (Inch)	Width (Inch)	Height (Inch)	Weight (LB)
7inch	7.93	7.93	1.50	1.25

Specifications

Series	CRI	Power	CCT	Lumens	Efficacy	Dimmable
HT-G2YCEDL-RD7-C12-XXS-ZZV	80/90	12W	2700/3000/3500/4000/5000K	1100/930LM	79/78LM/W	Y
HT-G2YCEDL-RD7-C14-XXS-ZZV	80/90	14W	2700/3000/3500/4000/5000K	1200/1000LM	79/71LM/W	Y

The integral battery option provides back up power to fixtures in hallways, corridors or other common areas.

Flush Mount Downlight - Round

Features

- Die cast aluminum housing routes heat away from electrical components
- 120 V and 120-277 V, 50/60Hz available
- PF > 0.9 - CRI > 90
- Precision engineered optical stack creates uniform light distribution that maximizes lumen output
- High quality glass lens ,edge to edge, for every lit spaces
- White tunable in 5 discrete color temperature 2700/3000/3500/4000/5000K, can be changed before, during or after installation
- 5 years limited warranty
- Smooth dimming feature and compatible with a wide variety of dimmers
- Round and Square shape for your optional

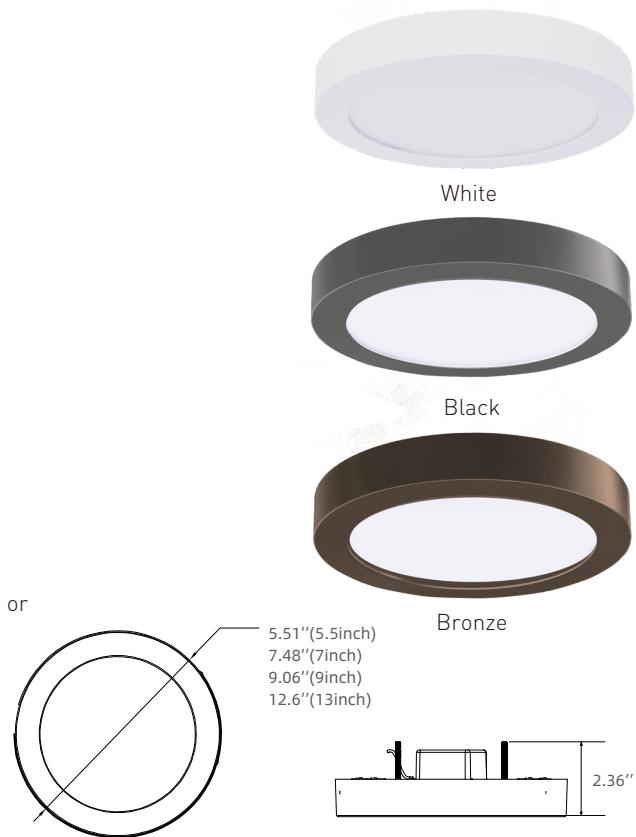

Dimension

Type	Length (Inch)	Width (Inch)	Height (Inch)	Weight (LB)
5.5inch	5.51	5.51	2.36	1.50
7inch	7.48	7.48	2.36	1.85
9inch	9.06	9.06	2.36	2.49
13inch	12.6	12.6	2.36	3.97

Specifications

Series	CRI	Power	CCT	Lumens	Efficacy	Dimmable
LJC-BMTD-G25.5CY10.5W-CXX-ZZ-V#	90	10.5W	27-30-35-40-50K	580 LM	55LM/W	Y
LJC-BMTD-G17CY13.5W-CXX-ZZ-V#	90	13.5W	27-30-35-40-50K	750 LM	64LM/W	Y
LJC-BMTD-G19CY18.5W-CXX-ZZ-V#	90	18.5W	27-30-35-40-50K	1050 LM	72LM/W	Y
LJC-BMTD-G113CY25W-CXX-ZZ-V#	90	25W	27-30-35-40-50K	1375LM	75LM/W	Y
LJC-BMTD-G35CY11W-27CXX-ZZ-V#	90	11W	27-30-35-40-50K	600 LM	55LM/W	Y
LJC-BMTD-G37CY14W-27CXX-ZZ-V#	90	14W	27-30-35-40-50K	900 LM	64LM/W	Y
LJC-BMTD-G39CY18W-27CXX-ZZ-V#	90	18W	27-30-35-40-50K	1300 LM	72LM/W	Y
LJC-BMTD-G313CY18W-27CXX-ZZ-V#	90	18.5W	27-30-35-40-50K	1400LM	75LM/W	Y

Flush Mount Downlight - Square

Features

- Die cast aluminum housing routes heat away from electrical components
- 120 V and 120-277 V, 50/60Hz available
- PF > 0.9 - CRI > 90
- Precision engineered optical stack creates uniform light distribution that maximizes lumen output
- High quality glass lens ,edge to edge, for every lit spaces
- White tunable in 5 discrete color temperature 2700/3000/3500/4000/5000K, can be changed before, during or after installation
- 5 years limited warranty
- Smooth dimming feature and compatible with a wide variety of dimmers
- Round and Square shape for your optional



White



Black

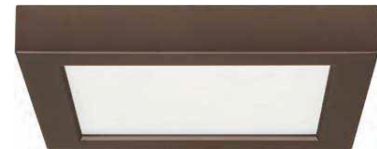

Bronze

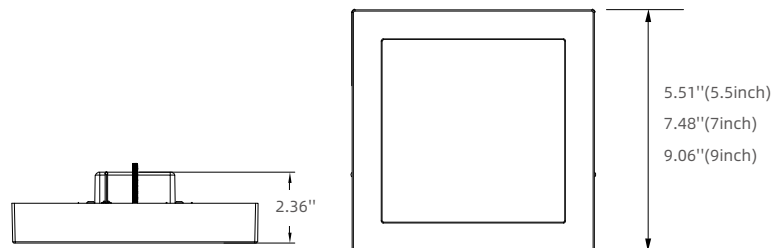

Dimension

Type	Length (Inch)	Width (Inch)	Height (Inch)	Weight (LB)
5.5inch	5.51	5.51	2.36	1.35
7inch	7.48	7.48	2.36	1.79
9inch	9.06	9.06	2.36	2.60

Specifications

Series	CRI	Power	CCT	Lumens	Efficacy	Dimmable
LJC-BMTD-G25.5CF10.5W-CXX-ZZ-V#	90	10.5W	27-30-35-40-50K	580 LM	55LM/W	Y
LJC-BMTD-G17CF13.5W-CXX-ZZ-V#	90	13.5W	27-30-35-40-50K	750 LM	56LM/W	Y
LJC-BMTD-G19CF18.5W-CXX-ZZ-V#	90	18.5W	27-30-35-40-50K	1050 LM	57LM/W	Y
LJC-BMTD-G35CF11W-27CXX-ZZ-V#	90	11W	27-30-35-40-50K	600 LM	55LM/W	Y
LJC-BMTD-G37CF14W-27CXX-ZZ-V#	90	14W	27-30-35-40-50K	900 LM	56LM/W	Y
LJC-BMTD-G39CF18W-27CXX-ZZ-V#	90	18W	27-30-35-40-50K	1300 LM	57LM/W	Y

1x1 and 1x2 Surface Mount Panel

Features

- Durable anodized aluminum frame with high reflective, matte powder coated paint
- High quality PMMA light guide plate creates uniform light, edge to edge, for every lit spaces
- Luminaires are available in 1x1, 1x2, ideal replacement for existing T8 lay-in troffer fixture, with a build-in power sources.
- Surface, pendant and recessed mounting options available
- White tunable in 5 discrete color temperatures 3000K/3500K/4000K/4500K/5000K. can be changed before, during or after installtion
- 120V input, 50/60Hz
- Ambient temperature: -20°C to 40°C
- 120V Triac dimming feature and compatible with a wide variety of dimmers
- UL and Energy Star certified

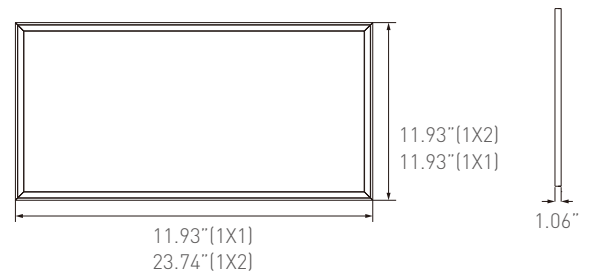

Applications

- Kitchens
- Bathrooms
- Hallways
- Meeting rooms
- Hospitality
- Health care
- Offices
- Retail

Mounting Accessories



Dimension

Type	Length (Inch)	Width (Inch)	Height (Inch)	Weight (LB)
1x1	11.93	11.93	1.06	2.85
1x2	23.74	11.93	1.06	5.71

Specifications

Series	CRI	Power	CCT	Lumens	Efficacy	Dimmable
HT-G3Y-USFP11-C10/UNV	80	10W	3000/3500/4000/4500/5000K	1000LM	100LM/W	Triac
HT-G3Y-USFP12-C18/UNV	80	18W	3000/3500/4000/4500/5000K	1800LM	100LM/W	Triac

1x4 Surface Mount Panel

Features

- Durable anodized aluminum frame with high reflective, light, edge to edge, for every lit spaces
- High quality PMMA light guide plate creates uniform
- Luminaires are available in 1X4 matte powder coated paint
- ideal replacement for existing T8/T12 lay-in troffer fixture, with a build-in power sources.
- Surface, pendant and recessed mounting options available
- White tunable in 3/5 discrete color temperatures 3000K/3500K/4000K/4500K/5000K. can be changed before. during or after installtion
- 120-277V or 120V input, 50/60Hz
- Ambient temperature: -20°C to 40°C
- Smooth 0-10V and 120V Triac dimming feature and compatible with a wide variety of dimmers
- UL and DLC standard compliance.

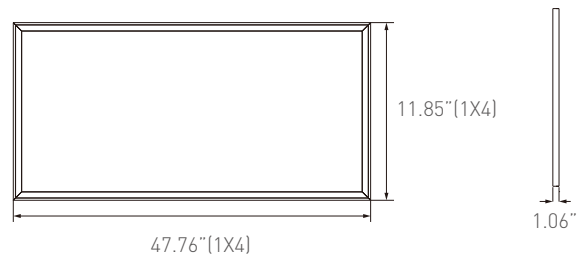

Applications

- Kitchens
- Bathrooms
- Hallways
- Meeting rooms
- Hospitality
- Health care
- Offices
- Retail

Mounting Accessories



Recessed Mount



Surface Mount



Pendant Mount

Dimension

Type	Length (Inch)	Width (Inch)	Height (Inch)	Weight (LB)
1x4	47.76	11.93	1.06	11.41

Specifications

Series	CRI	Power	CCT	Lumens	Efficacy	Dimmable
HT-G3Y-USFP14-C40/UNV	80	40W	3000-4000-5000K	4000LM	100LM/W	0-10V

2X2 Surface Mount Panel

Features

- Durable anodized aluminum frame with high reflective, matte powder coated paint
- High quality PMMA light guide plate creates uniform light, edge to edge, for every lit spaces
- Luminaires are available in 2X2.
ideal replacement for existing T8/T12 lay-in troffer fixture, with a build-in power sources.
- Surface, pendant and recessed mounting options available
- White tunable in 3/5 discrete color temperatures 3000K/3500K/4000K/4500K/5000K. can be changed before, during or after installtion
- 120-277V or 120V input, 50/60Hz
- Ambient temperature: -20°C to 40°C
- Smooth 0-10V and 120V Triac dimming feature and compatible with a wide variety of dimmers
- UL and DLC standard compliance.

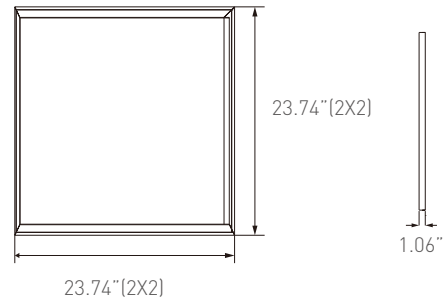
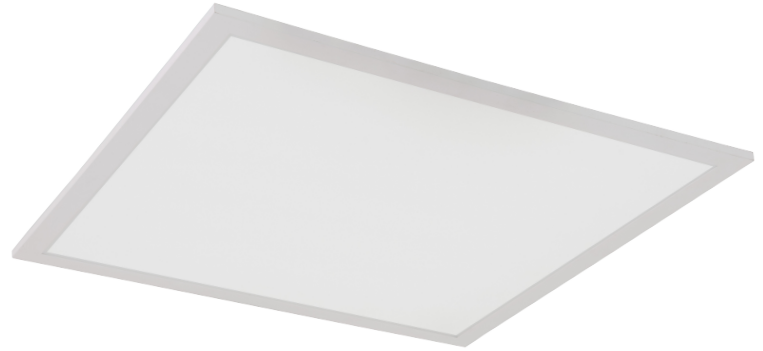

Applications

- Kitchens
- Bathrooms
- Hallways
- Meeting rooms
- Hospitality
- Health care
- Offices
- Retail

Mounting Accessories



Recessed Mount



Surface Mount



Pendant Mount

Dimension

Type	Length (Inch)	Width (Inch)	Height (Inch)	Weight (LB)
2x2	23.74	23.74	1.06	11.41

Specifications

Series	CRI	Power	CCT	Lumens	Efficacy	Dimmable
HT-G3Y-USFP22-C40/UNV	80	40W	3000-4000-5000K	4000LM	100LM/W	0-10V

2X4 Surface Mount Panel

Features

- Durable anodized aluminum frame with high reflective, matte powder coated paint
- High quality PMMA light guide plate creates uniform light, edge to edge, for every lit spaces
- Luminaires are available in 2X4. ideal replacement for existing T8/T12 lay-in troffer fixture, with a build-in power sources.
- Surface, pendant and recessed mounting options available
- White tunable in 3/5 discrete color temperatures 3000K/3500K/4000K/4500K/5000K. can be changed before. during or after installtion
- 120-277V or 120V input, 50/60Hz
- Ambient temperature: -20°C to 40°C
- Smooth 0-10V and 120V Triac dimming feature and compatible with a wide variety of dimmers
- UL and DLC standard compliance.

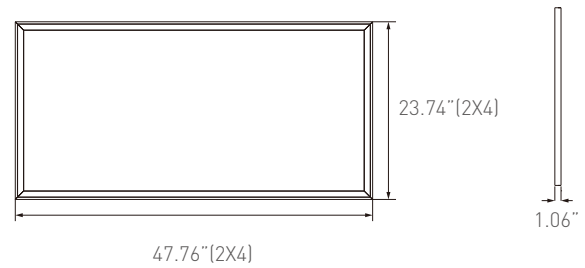

Applications

- Kitchens
- Bathrooms
- Hallways
- Meeting rooms
- Hospitality
- Health care
- Offices
- Retail

Mounting Accessories



Recessed Mount



Surface Mount



Pendant Mount

Dimension

Type	Length (Inch)	Width (Inch)	Height (Inch)	Weight (LB)
2x4	47.76	23.74	1.06	22.83

Specifications

Series	CRI	Power	CCT	Lumens	Efficacy	Dimmable
HT-G3Y-USFP24-C50/UNV	80	50W	3000-4000-5000K	5000LM	100LM/W	0-10V